

Growing toward the global...

We are always working diligently to create a better future for our world with innovative and Eco-friendly access and transit management systems.



*Some countries may not show on above map



Safety In Your Life

The professional manufacturer & solution provider of ELEVATOR & ESCALATOR

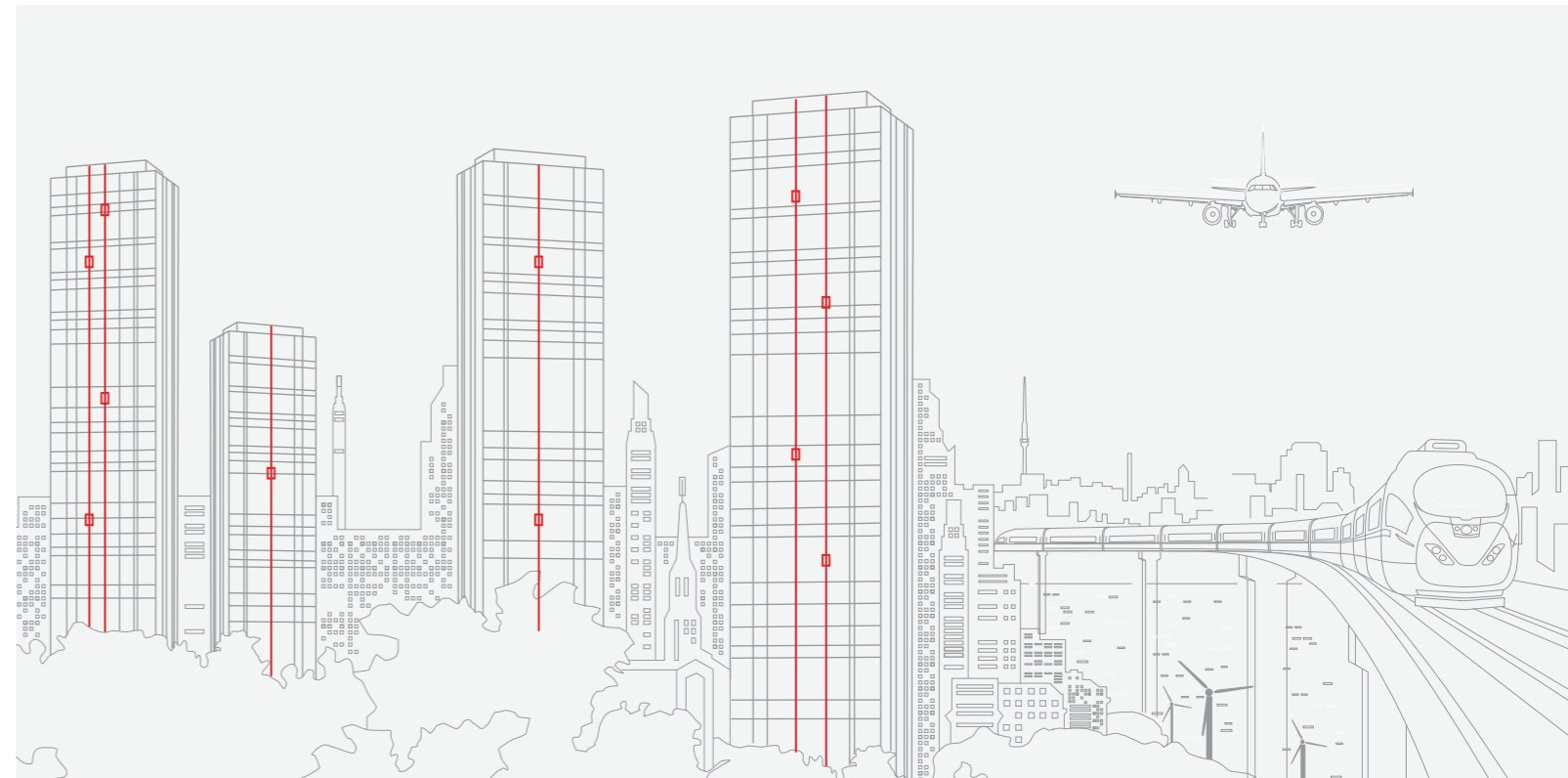

Ver. J-CAT-EN191101/Nov. 202312

Joylive Elevator Co.,Ltd.
(Manufacturing Center & Headquarters)

No. 322, Maoxu Rd., Bacheng, Kunshan,
Suzhou City, Jiangsu Province, China
Tel: (+86) 156 1872 5928 (Whatsapp/Wechat)
M: info@joylive-lift.com / joylive.lift@gmail.com
W: www.joylive.com / www.joylivelift.com

Joylive Asia Pacific Pte. Ltd.
(Singapore)

35 Kallang Pudding Road #03-01 Tong
Lee Building, Singapore 349314
M: sgp@joylive-lift.com

Joylife Intelligence System Co., Ltd.
(Software and IoT R&D Center)

404, Building A2, Ascendas iHub Suzhou, 388 Xin
Ping Street, Suzhou Industrial Park, China
M: info@joylive-lift.com



Contact by Whatsapp



Company website

The product information in this catalog is subject to change without prior notice. The printed color could be different from the actual object. Unauthorized copy or use of the contents of this catalog is prohibited. All rights are reserved by Joylive Elevator Co., Ltd. Copyright © 2002-2023 JOYLIVE Corporation.

Joylive Elevator Co., Ltd.
www.joylive.com

Our brands:

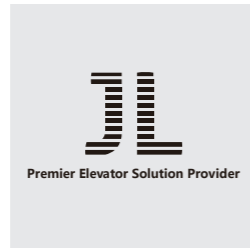

ABOUT JOYLIVE

Specialization makes us doing better

Joylive Elevator Co., Ltd. (Previously called Suzhou Great Elevator) is the China premier solution provider of elevators, escalators and related services. It was established in Kunshan (60km to Shanghai), Suzhou city in 2002 and went to public in September 2015. With 2 manufacturing centers of 105,000 square meters and more than 700 employees, it can product 18, 000 units elevator and escalator per year. The products include Joycity – Business Passenger Elevators, Joylife – Residential Passenger Elevators, Joyvilla – Home Elevators, Joylogi – Freight Elevators, Joywalk – Escalators, and Autowalks.

The company focuses on creating a nationwide marketing and service network system integrating sales, engineering, and services. At the same time, it actively explores international market. After continuous development, Joylive Elevator's sales and service network have covered more than 100 countries including Russia, Middle Asia, Latin America, New Zealand, Australian, Southeast Asia, Middle East, and Africa etc.

Joylive insists on quality and brand building and has maintained rapid growth for many years. It is determined to develop into a high-end manufacturing and service company. We will continue to offer the devised products with high quality to the clients, and endeavor to be the most competitive elevator enterprises in the world and the first elevator brand choice of customers.



70, 000 m2 area manufacturing factory with 118 m height test tower

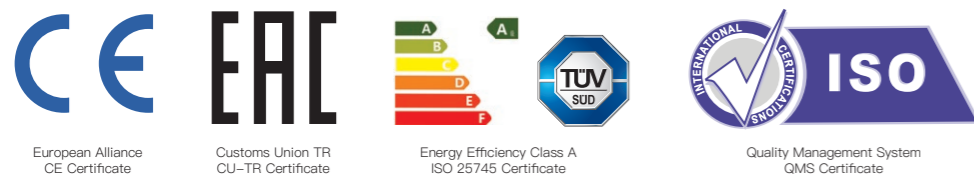

Our offering

Smart and secure access solutions for variety clients' needs

Joylive's product portfolio is set up to provide an optimal mobility solution for modern buildings and urban environments such as residential properties, offices, airports, hospitals, hotels, villas, stadiums and malls & retail projects. By around 700 experienced and committed employees, we now deliver even more comprehensive and innovative products, solutions and services for customers around the world.



Residential Passenger Elevator

Simple and practical for smaller residential buildings. Optimal solution that meets the essential requirements in terms of performance, design and other options, low costs and greater convenience.



Commercial Passenger Elevator

For commercial and high-end residential buildings allowing flexible combination of system layout, which makes it suitable for special applications like hotels, shopping centers and public buildings.



Hospital Elevator

Safe, smooth and reliable elevator designed especially for hospitals, with a solid set of features for optimum performance in the highly demanding environment of patient transportation.

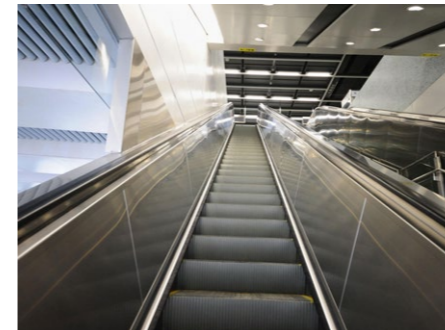

Escalator & moving walk

Meets the specific requirements of commercial buildings and public transport applications; with various configuration packages, dependable performance and passenger safety.



Vehicle Elevator

The powerful and high performance vehicle elevator solution is ideal for demanding vertical freight transportation tasks in supermarkets, shopping malls and private house.

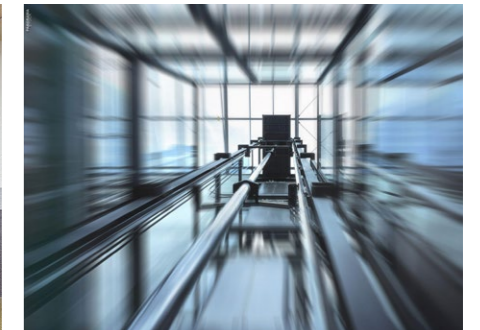

Hydraulic Elevator

Tailor-made services and customized solution, Safe and reliable with electric valves, adjustable speeds. Not necessary to make major works. Possibility of using organic fluid.



Panoramic Elevator

High-quality system solutions made from glass — for a wide range of everyday and office applications. Solid energy saving traction elevator, available as Machine Room Less or Mini Machine Room configuration.



Freight Elevator

A heavy-duty elevator for buildings with demanding requirements for service and goods transport. Solid set of standard features specially designed to goods transportation requirements.

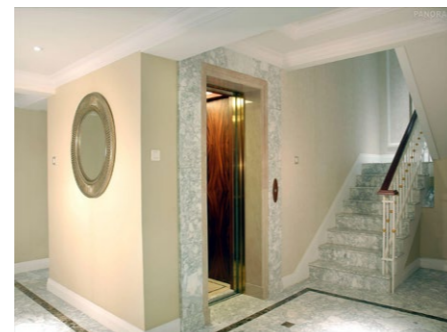

Home Elevator

Provide directional elevator custom service for top luxury market. Offers a certain design and dimensioning flexibility, providing green mobility, smart operations and space efficiency.



Dumbwaiter

Suitable for big and small restaurant to transport food and goods; High quality materials, small space needed with compact structure.

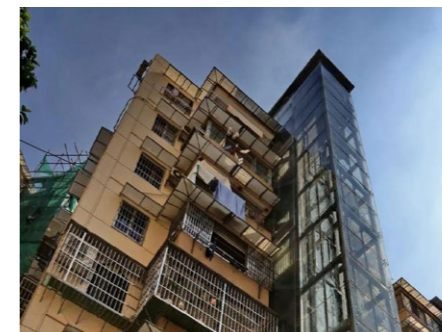

Modernization and Upgrading

Boost your elevator's reliability, ecoefficiency, comfort, and appearance — and bring it in line with the latest safety and accessibility standards — with our modernization solutions for all needs and budgets.

Global reach, local focus

Explore our significant projects

Domestic Projects



Hi-tech industrial development zone (Zibo city 64 units)



Guanfu International (Haerbin 155 units)



Xihu Spring (Shangqiu 86 units)



Northern Bay (Hefei 56 units)



Hanlinxuefu (Baoding 84 units)



Pharmaceutical city (Taizhou 52 units)



Mulong Wan (Kunsan 176 units)



Changxin central plaza (Anshun 64 units)



Airport comprehensive economic pilot zone (Zhengzhou 84 units)



Yangcheng Lake RE (Kunshan 304 units)



Coastal City Plaza (Kunming 40 units)



New world city (Beijing 60 units)



Hilton Jinshi Hotel (Guiyang, 21 units)



Yigu international mall (Suzhou 32 units)



Hitachi Construction (Suzhou 14 units)



Midea Group (Hefei City 18 units)

Overseas Projects



Desa Hill Villa Area (Malaysia 426 units)



Isfahan Corridor Escalator (Iran 143 units)



Lake Town Apart, Almaty (Kazakhstan 18 units)



European University of Bangladesh (EUB 34 units)



Crimean Clinical Hospital (Russia 14 units)



Crowne Plaza Hotel (New Zealand 5 units)



Korba Heights (Egypt 12 units)



Avicena (Tajikistan 18 Units)



Bankstown Airport (Australia 5 units)



Royal Swiss Lahore (Pakistan 11 units)



City Park Yaroslavl (Russia 18 units)



Beneficencia Del Valle (Colombia 6 units)



WISTRON INFOCOMM (Vietnam 36 Units)



Government affordable houses (Uzbekistan 689 units)



The Sands Apartments & Mall (Panama 12 units)









Joycloud ELEVATOR IoT PLATFORM

The world is changing more rapidly than ever before, thus bringing about new ways of doing things. With new endeavors come new obstacles that require modern solutions. Doing more with less has set the road for Elevator IoT (Internet of Things). We provide cutting-edge technology to address all of our client's needs, from automation to tracking. We work beyond the conventional theories to deliver various services and solutions using IoT. To every potential problem, we can offer a viable and swift solution. Our team has the ability to gather the specifications, develop a solution and immediately deliver results. Whatever your vertical transportation IoT, elevator IoT or escalator IoT you want to full; The Elevator Consultants has the technical expertise to accommodate your every need. Our team consists of development experts with domain expertise ready to work with you on jobs big and small. Call today to discuss how The Elevator Consultants can work with you to provide modern and economical vertical transportation solutions.

ELEVATOR IoT PLATFORM

Providing digital services for elevator running



 <p>Dynamic Diagnosis</p> <p>Key components are dynamically detected. When abnormal or close to service life is found, the system automatically warns, and eliminates hidden trouble through predictive maintenance.</p>	 <p>Remote monitoring</p> <p>Remote data collection, monitoring, efficient management and control of real-time information.</p>
 <p>Online installation</p> <p>From manufacturing to delivery and handover to the owner, the whole installation process is fully monitored.</p>	 <p>Online Maintenance</p> <p>Automatically generate elevator exclusive health records and maintenance diagnosis reports. Preset maintenance time, real-time monitoring, feedback maintenance progress.</p>
 <p>Grid Rescue</p> <p>When elevator breaks down, the system prompts and makes accurate positioning, monitoring center will dispatch engineer to site for rescue.</p>	 <p>Interactive system</p> <p>Joycloud 4.0, to provide more innovative digital services, integrating rich interactive experience between smartphone and elevator by voice, video and other multimedia.</p>

* Optional function

Scan the QR code to download the JoyCloud App



Joycloud Android



Joycloud ios

Innovative technology & Safety assurance



- Double 32-bit microcomputer control system
- Intelligent integrated control drive
- Precise control of lift running position
- Accurate and stable leveling

INTELLIGENT CONTROL SYSTEM (Monarch®)



- Quiet work and smooth running with PM motor
- Adjustable opening speed
- Life up to 5 million cycles

DOOR SYSTEM

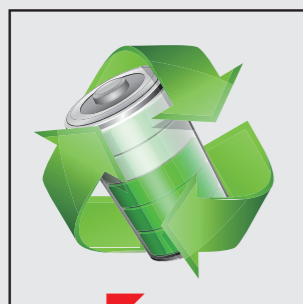

- Highly energy-saving energy feedback technology based on AFE control can feed the renewable green electric energy, save more than 30% energy compared to common VVVF elevators on average.

ENERGY REGENERATION TECHNOLOGY *



- Various shock absorption measures to reduce vibration conduction.
- Configured with sound insulation, noise reduction measures to enhance ride comfort and user experience.

SHOCK ABSORPTION AND NOISE REDUCTION SYSTEM

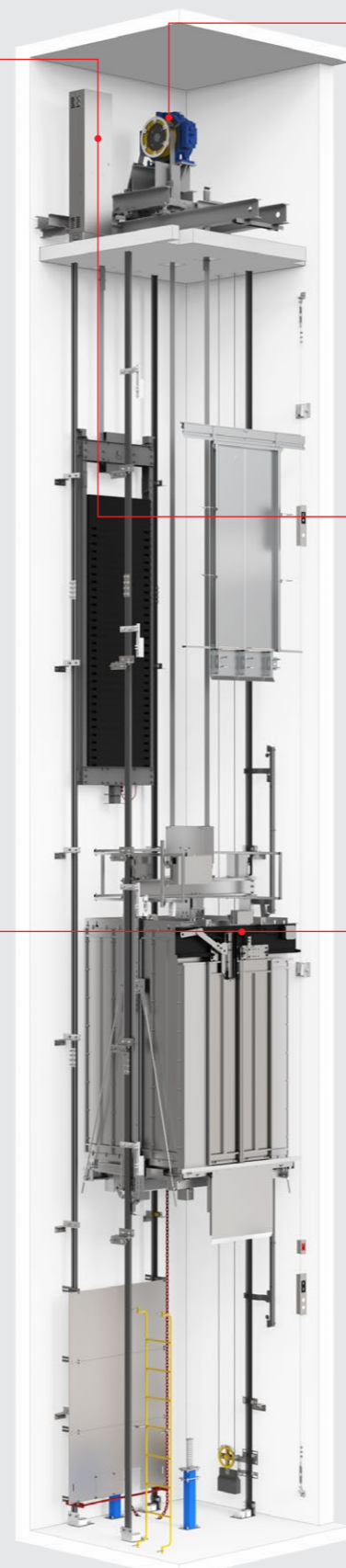

GP30 MR

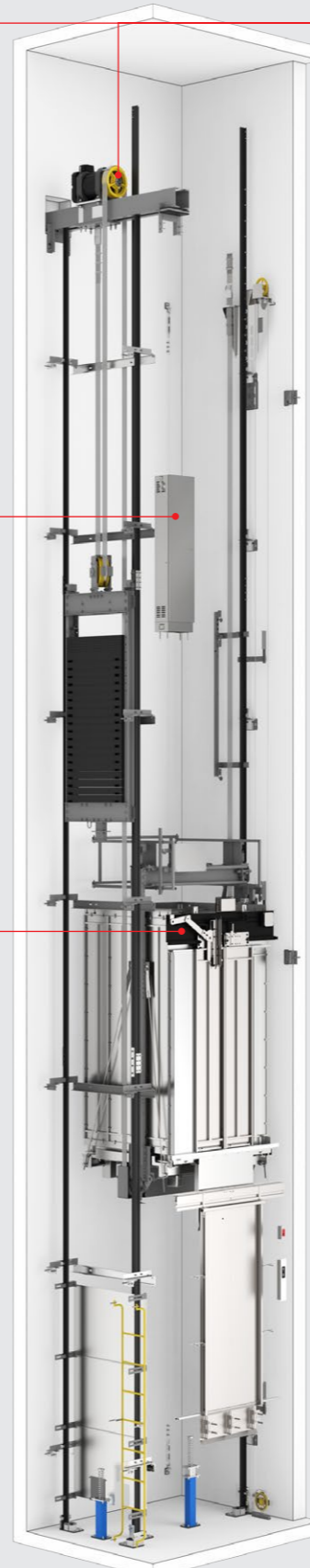

GPN30 MRL

- Excellent Japanese quality
- Compact size and reduced weight
- Each motor passes mechanical and electrical test
- High strength design for key components

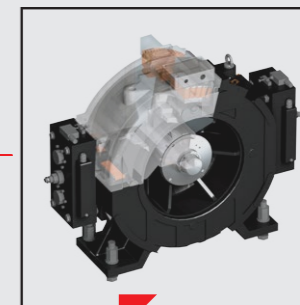

TRACTION MOTOR BRAKE FORCE SELF-DETECTION

- Standby power consumption is less than 50W, save more than 40% energy

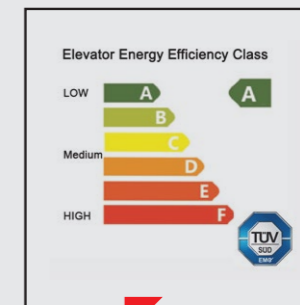

ISO25745 CLASS-A, HIGHEST ENERGY SAVING CERTIFICATE

- Prevent passengers been trapped during power failure
- Modular structure design, easy maintenance Intelligent battery management, urable life



ARD (AUTOMATIC RESCUE DEVICE) *

- Pre-engineered components for modular assembly system, as well as strict quality control greatly improve on-site installation quality and efficiency.

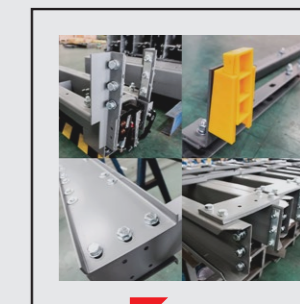

MODULAR ASSEMBLY

* Optional features

Integrated design, Quality upgrade

Design Iteration

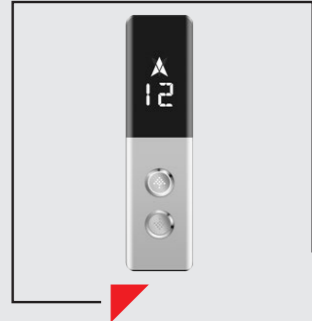

HOP Design

Curved screen design with anti-fingerprint frosted stainless steel as faceplate, beautiful looking and easy to clean up.

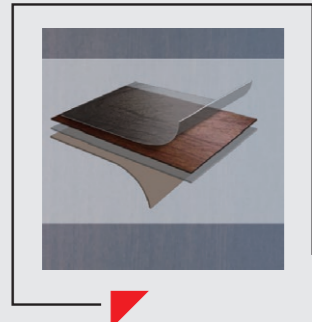

New Decoration Material

Laminated hot-melt decorative steel plate, more uniform adhesion and better tensile resistance effect on protective layer, to avoid the problem of bending and cracking. More diversified patterns and textures to choose on page 35.

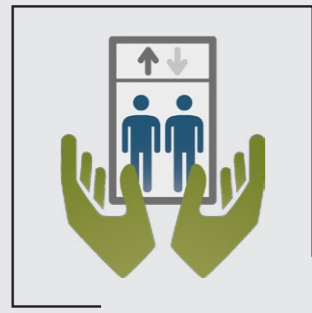

Comply with EN81-20 & EN81-50 European, Australian and other standards

UCMP (Unintended Car Movement Protection System), ACOP (Ascending Car Overs-peed Protection), and other safety solution, which includes speed monitoring and speed reducing elements to detect uncontrolled movement of the ascending lift car or unintended lift car movement away from landing, make the lift car to stop or at least reduce its speed to protect passenger safe.



Easily Recognizable Micro-light Button *

Micro-light design for standby status of buttons improves the recognition of floor numbers, ensuring floor numbers on buttons can be read fast in dim environment.

CNAS Laboratory Verification

Joylive Elevator CNAS national accredited laboratory has been accredited for 29 test items in total, and the test report issued is completely tested in accordance with national standards. When product design is completed, the laboratory conducts test verification and issues a test report.

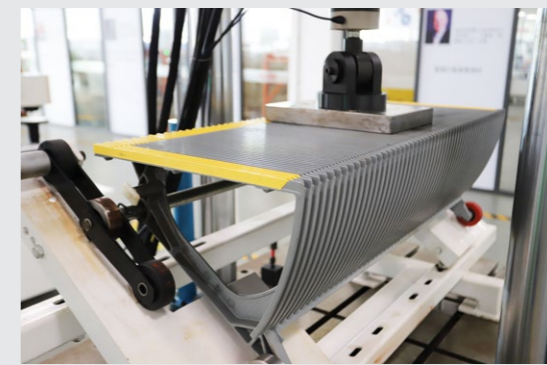
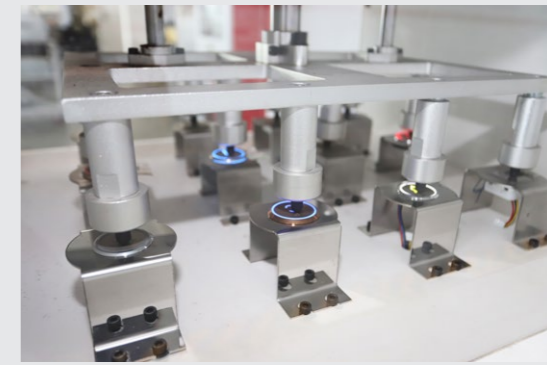

All-in-One Lift Access Control System *

Fingerprint, Bluetooth and IC card entification, 3-in-1 access controller, easy to use. Security control can manage rights of users with different roles, such as managers, employees, administrators, to protect the privacy and security of owners or enterprises. Smart, reliable and easy to use, which are guaranteed to make life safer and easier.

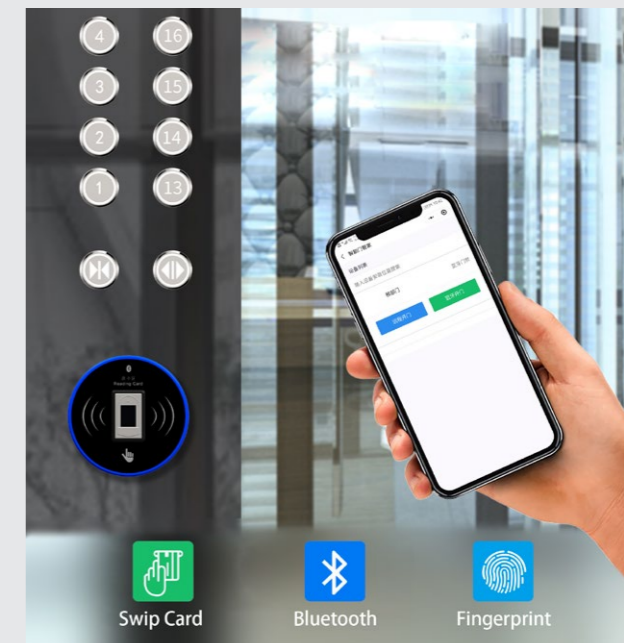

* Optional features

Cabin design

- > Wide cabin design, to give passenger more feeling of comfortable.
- > Full height integrated COP, high-end and elegant design.

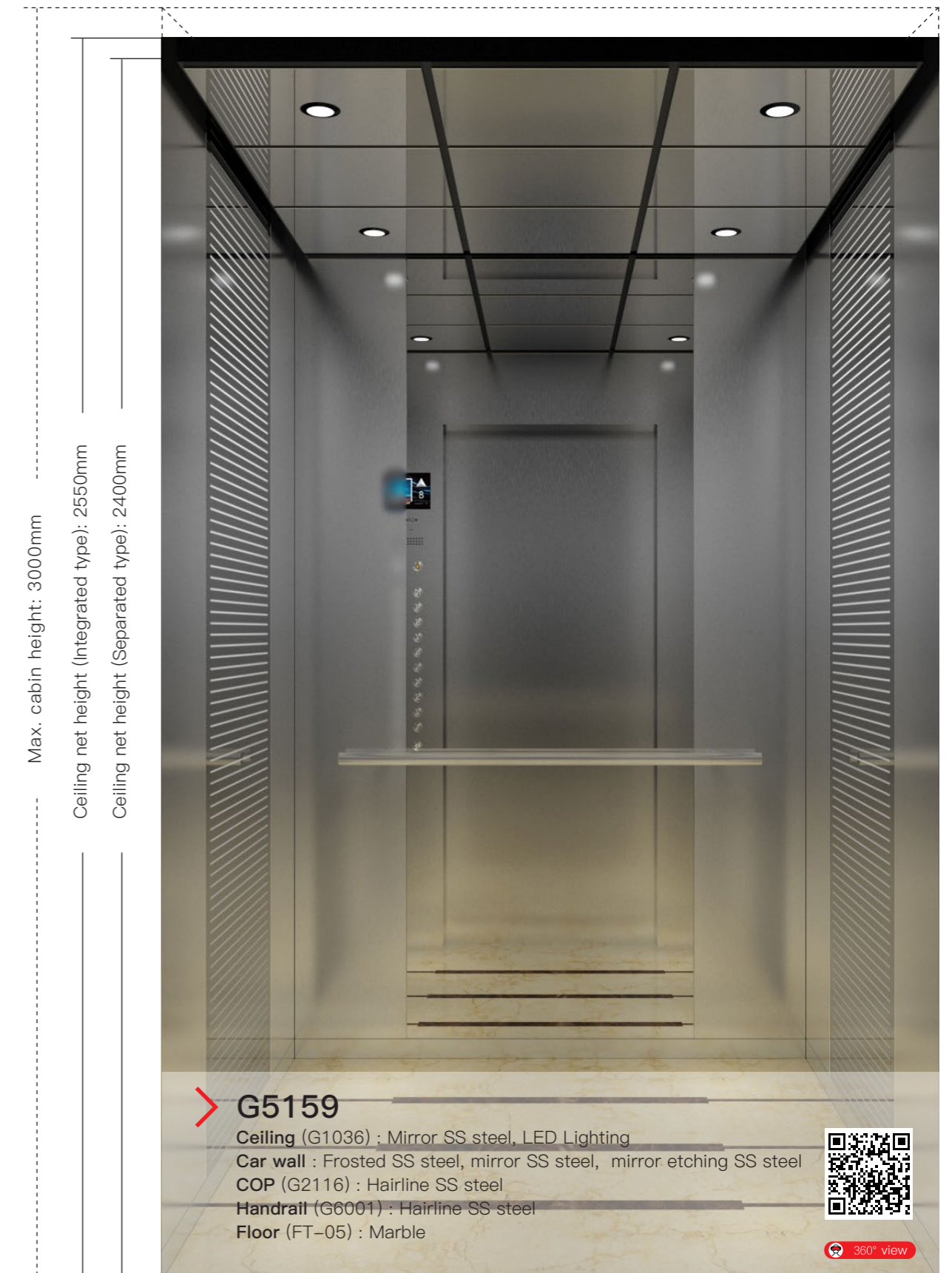



G5292



360° view

Ceiling (G1089) : Hairline SS steel, LED Lighting
Car wall : Hairline SS steel, mirror SS steel
COP (G2113) : Hairline SS steel
Handrail (G6001) : Hairline SS steel
Floor (G3121) : PVC



G5288



360° view

Ceiling (G1090) : Hairline SS steel, LED Lighting
Car wall : Film laminated steel (G4441), mirror SS steel
COP (G2113) : Hairline SS steel
Handrail (G6001) : Hairline SS steel
Floor (G3121) : PVC



G5289



360° view

Ceiling (G1094) : Hairline SS steel, LED lighting
Car wall : Hairline SS steel, mirror SS steel
COP (G2116) : Hairline SS steel
Handrail (G6001) : Hairline SS steel
Floor (G3121) : PVC



G5162



360° view

Ceiling (G1011) : Mirror SS steel, LED lighting
Car wall : Hairline SS steel, Mirror etching SS steel(G4207)
COP (G2116) : Hairline SS steel.
Handrail (G6001) : Hairline SS steel
Floor (FT-01) : Patterned marble



G5286



360° view

Ceiling (G1093) : Soft membrane, LED lighting
Car wall : Film laminated steel (G4441), mirror SS steel, hairline SS steel
COP (G2116) : Mirror SS steel
Handrail (G6001) : Hairline SS steel
Floor (G3363) : Patterned marble



G5160



360° view

Ceiling (G1010) : Mirror SS steel, LED lighting
Car wall : Hairline SS steel, Mirror etching SS steel (G4212)
COP (G2116) : Hairline SS steel
Handrail (G6001) : Hairline SS steel
Floor (FT-03) : Patterned marble



G5155



360° view

Ceiling (G1010) : Hairline SS steel, LED lighting
Car wall : Hairline SS steel, mirror etching SS steel
COP (G2116) : Hairline SS steel
Handrail (G6001) : Hairline SS steel
Floor (G3353): Marble

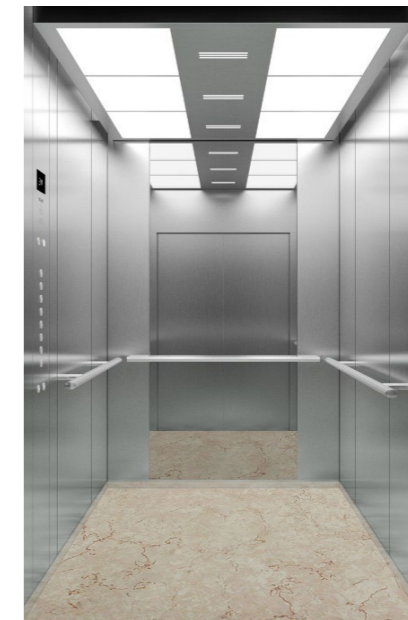

G5156



360° view

Ceiling (G1017) : Hairline SS steel, LED lighting
Car wall : Hairline SS steel, Mirror SS steel
COP (G2116) : Hairline SS steel
Handrail (G6001) : Hairline SS steel
Floor (G3124) : PVC



G5339

Ceiling (G1010) : Hairline SS steel, LED Lighting
Car wall : Hairline SS steel, 1/2 height Mirror
COP (G2116) : Hairline SS steel
Handrail (G6001) : Hairline SS steel
Floor (FT-03) : Marble



G5195

Ceiling (G1008) : Hairline SS steel, LED lighting
Car wall : Hairline SS steel, mirror SS steel
COP (G2116) : Hairline SS steel
Handrail (G6001) : Hairline SS steel
Floor (FT-06) : Patterned marble

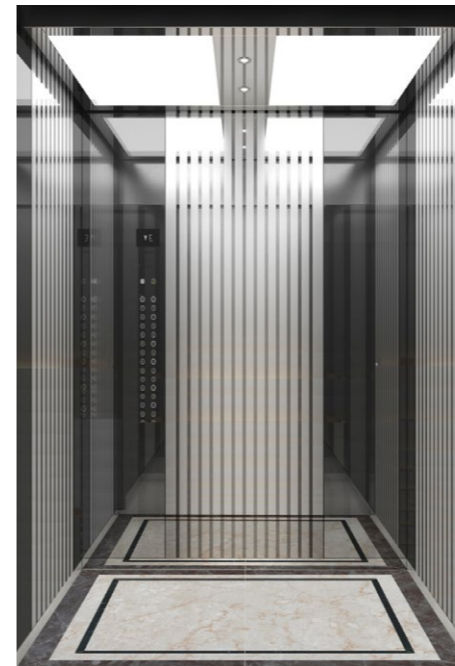

G5340

Ceiling (G1108): Mirror SS steel, LED lighting
Car wall : Mirror SS steel, Mirror etching SS steel(G4271)
Floor (G3378): PVC

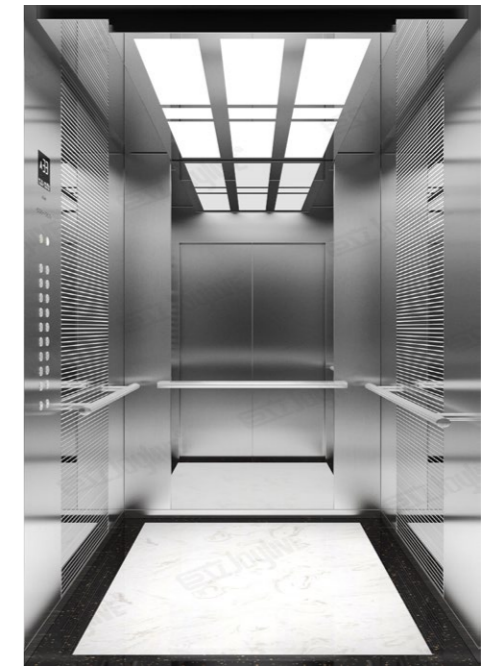

G5332

Ceiling (G1044): Mirror SS steel, LED lighting
Car wall : Hairline SS steel, Mirror etching SS steel(G4213)
Handrail (G6001): Round type, Hairline SS steel
Floor (FT-03): Patterned marble



G5308

Ceiling (G1068) : Mirror SS steel, LED lighting
Car Wall : Mirror SS steel, Mirror etching SS steel (HM-43)
COP (G2113) : Mirror SS steel
Handrail (G6001) : Mirror SS steel
Floor (G3374) : Patterned PVC

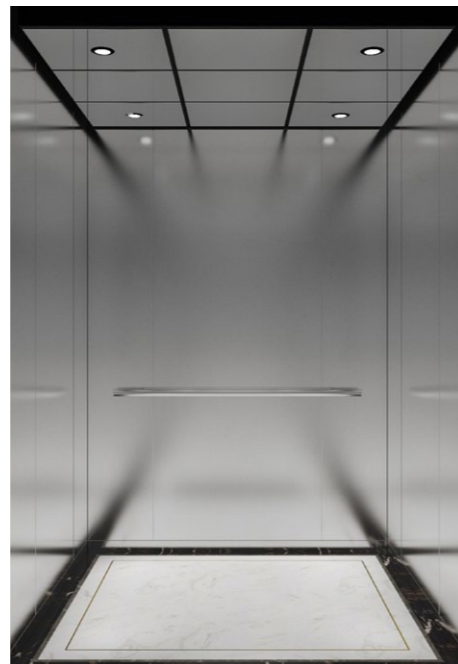

G5300

Ceiling (G1036) : Mirror SS steel, LED lighting (Suggest for $\geq 1000\text{kg}$ capacity)
Car wall : Hairline SS steel
COP (G2116) : Hairline SS steel
Handrail (G6001) : Hairline SS steel
Floor (G3364) : Patterned marble



G5341

Ceiling (G1011): Mirror SS steel, LED lighting
Car wall : Mirror SS steel, Mirror etching SS steel(G4238)
Handrail (G6003): Flat type, Mirror SS steel
Floor (FT-06): Patterned marble

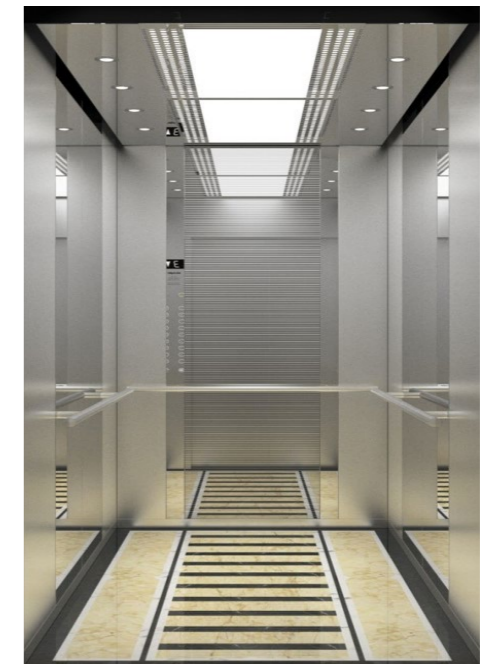

G5333

Ceiling (G1062): Mirror SS steel, LED lighting
Car wall : Mirror SS steel, Mirror etching SS steel(G4213)
Handrail (G6001): Round type, Hairline SS steel
Floor (G3337): Patterned marble

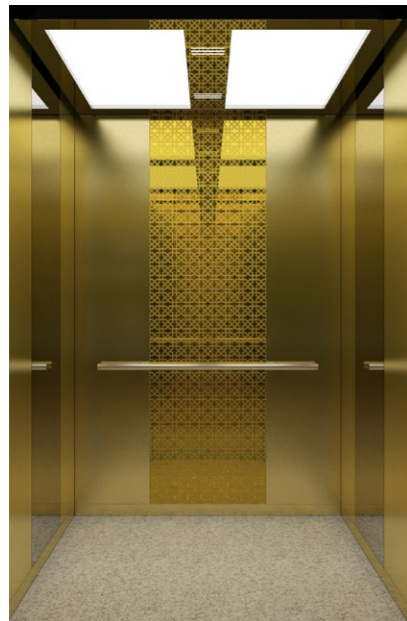

G5278



360° view

Ceiling (G1008) : Golden mirror SS steel, LED Lighting
Car wall : Golden hairline SS steel, golden mirror SS steel, golden mirror etching SS steel (HM-36)
COP (G2116) : Golden mirror SS steel
Handrail (G6001) : Golden hairline SS steel
Floor (G3313) : Marble

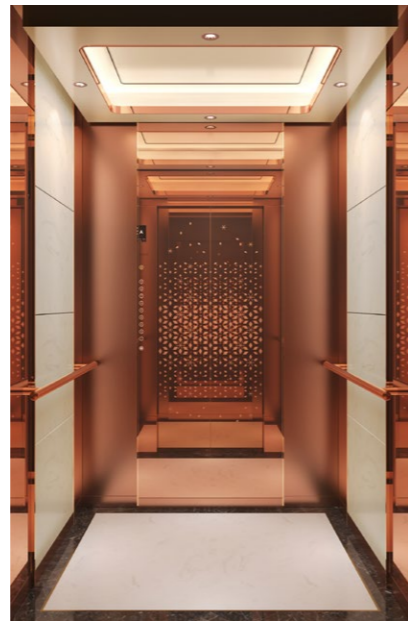

G5298



360° view

Ceiling (G1092) : Rose golden mirror SS steel, LED lighting
Car wall : Rose golden mirror SS steel, rose golden frosted SS steel, marble
COP (G2116) : Mirror SS steel
Handrail (G6001) : Rose golden mirror SS steel
Floor (G3353) : Patterned marble

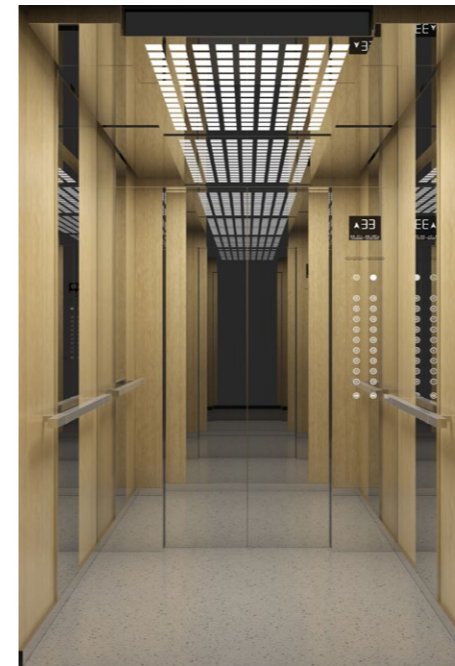

G5342

Ceiling(G1048): Mirror SS steel, LED lighting
Car wall : Mirror SS steel, Film laminated steel (LG-CW427)
Handrail (G6011): Square tube SS steel
Floor (G3337): Patterned marble

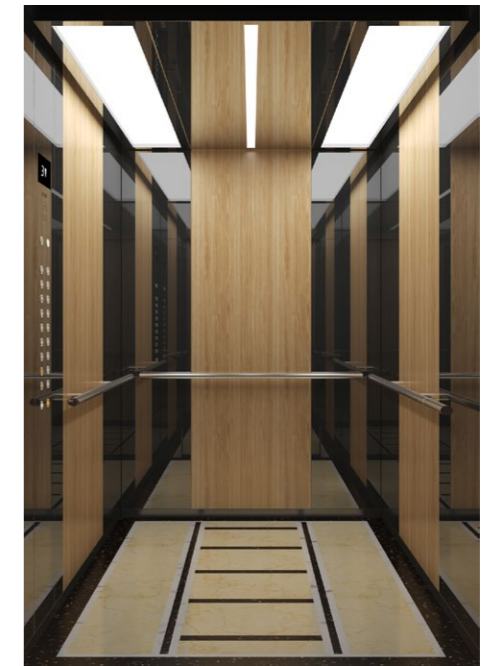

G5343

Ceiling (G1065): Black mirror SS steel, LED lighting
Car wall : Black mirror SS steel, Film laminated steel (LG-CW427)
Handrail (G6001): Hairline SS steel
Floor (G3337): Patterned marble



G5163



360° view

Ceiling (G1017) : Golden mirror SS steel, LED lighting
Car wall : Golden hairline SS steel, golden mirror SS steel, golden mirror etching SS steel(G4207)
COP (G2116) : Golden hairline SS steel
Handrail (G6001) : Golden hairline SS steel
Floor (G3315) : Patterned marble

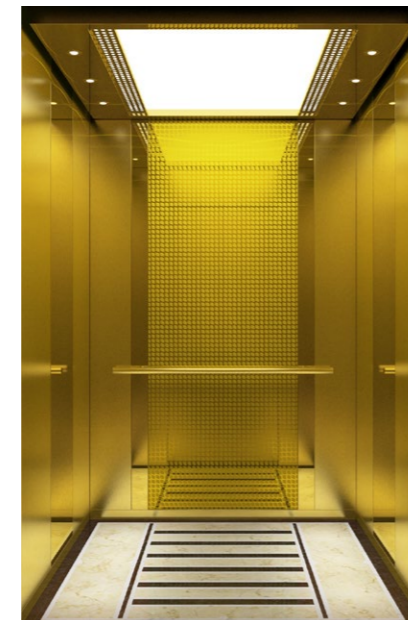

G5230



360° view

Ceiling (G1062) : Golden mirror SS steel, LED lighting
Car wall : Golden hairline SS steel, golden mirror SS steel, golden mirror etching SS steel(G4230)
COP (G2116) : Golden hairline SS steel
Handrail (G6001) : Golden hairline SS steel
Floor (G3337) : Patterned marble

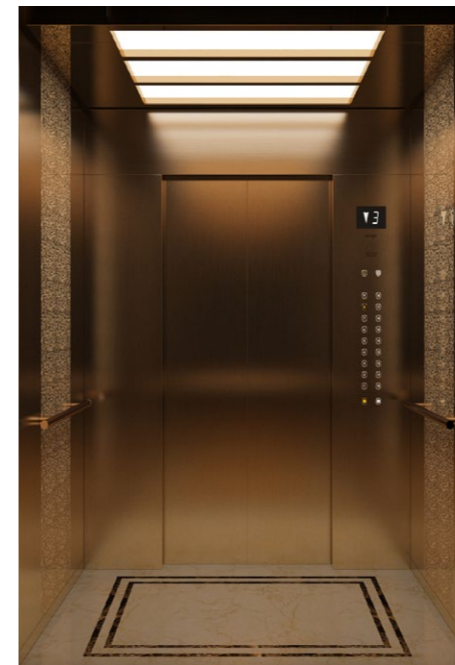

G5344

Ceiling (G1010): Bronze Mirror SS steel, LED lighting
Car wall : Bronze frosted SS steel, Bronze mirror etching SS steel (G4207)
Handrail (G6001): Bronze frosted SS steel
Floor (G3315): Patterned marble

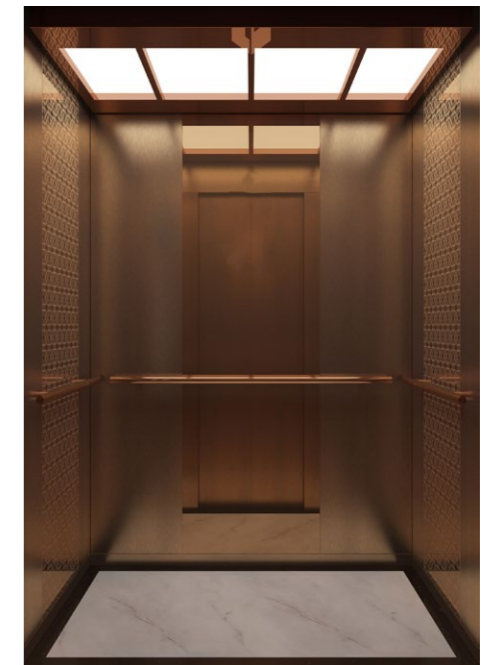

G5345

Ceiling (G1010): Bronze Mirror SS steel, LED lighting
Car wall : Bronze frosted SS steel, Brass mirror etching SS steel (G4207)
Handrail (G6001): Bronze frosted SS steel
Floor (G3353): Patterned marble

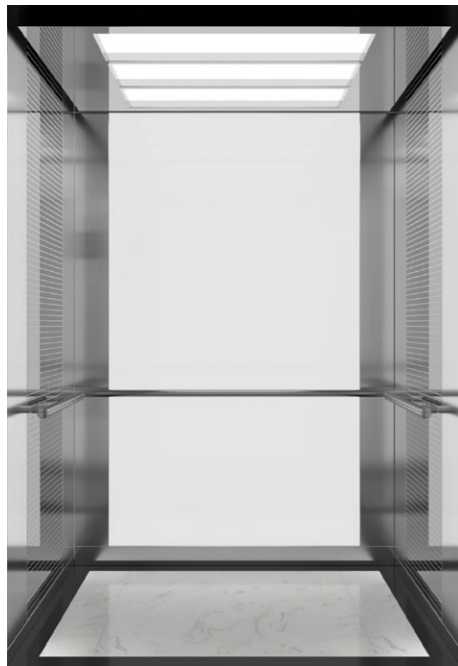

G5336

Ceiling (G1010): Mirror SS steel, LED lighting
Car wall : Mirror SS steel, Mirror etching SS steel(G4213), Tempered safety glass
Handrail (G6001): Round type, Hairline SS steel
Floor (FT-03): Patterned marble

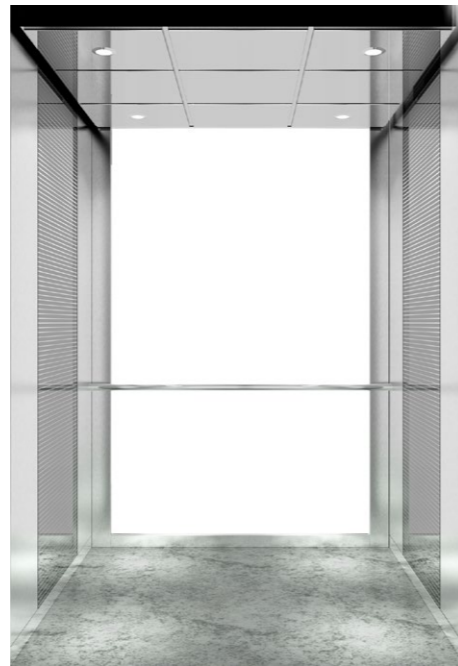

G5337

Ceiling (G1036): Mirror SS steel, LED lighting
Car wall : Mirror SS steel, Mirror etching SS steel(G4213), Tempered safety glass
Handrail (G6001): Hairline SS steel
Floor (G3101): PVC



G5310

Upper and lower cover: Hairline SS steel, Acrylic
Ceiling(G1110): Hairline SS steel, LED lighting
Car wall: Hairline SS steel, Tempered safety glass
COP(G2113): Hairline SS steel
Floor(G3384): PVC



G5338

Upper and lower cover: Hairline SS steel, Acrylic
Ceiling(G1010): Hairline SS steel, LED lighting
Car wall: Mirror SS steel, Tempered safety glass
COP(G2116): Mirror SS steel
Floor(G3122): PVC



G5202

Ceiling (G1008) : Hairline SS steel, LED lighting
Car wall : Hairline SS steel, Tempered safety glass
COP (G2116) : Hairline SS steel
Handrail (G6001) : Hairline SS steel
Floor (G3308) : Marble



G5346

Ceiling (G1062) : Golden mirror SS steel, LED lighting
Car wall : Golden hairline SS steel, golden mirror SS steel, Tempered safety glass
COP (G2116) : Golden hairline SS steel
Handrail (G6001) : Golden hairline SS steel
Floor (G3337) : Patterned marble



G5312

Upper and lower cover: Hairline SS steel, Acrylic
Ceiling(G1111): Hairline SS steel, LED lighting
Car wall: Hairline SS steel, Tempered safety glass
COP(G2113): Hairline SS steel
Floor(G3385): PVC



G5309

Upper and lower cover: Hairline SS steel, Acrylic
Ceiling(G1109): Hairline SS steel, LED lighting
Car wall: Hairline SS steel, Tempered safety glass
COP(G2113): Hairline SS steel
Floor(G3383): PVC

Signal fixtures

COP & HOP Designs

Brand new designed human-machine interaction apply to variety of architectural styles.

The brand new designed COP and HOP apply to a majority of architectural occasions, providing various styles and satisfying diversified customer requirements.

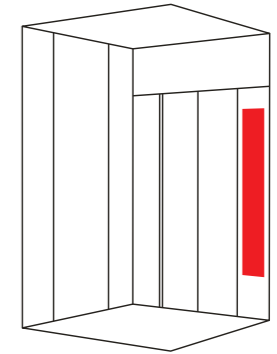

Half height COP

Standard

Optional



G2113
Split embedded



G2209
Embedded



G2248
Wall-hanging



G2142
Split embedded

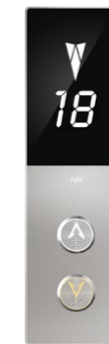

G2245
Wall-hanging

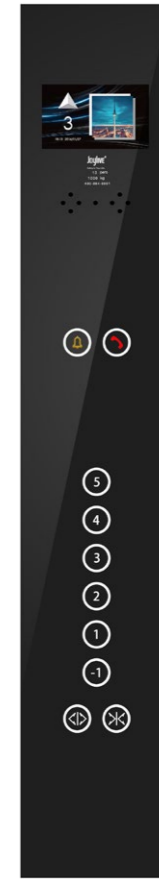

G2141
Glass faceplate
Split embedded



G2243
Glass faceplate
Embedded

Full Height COP (Optional)



G2116
Integrated

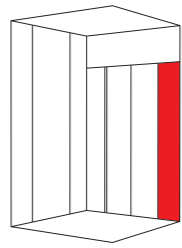

G2253
Wall-hanging

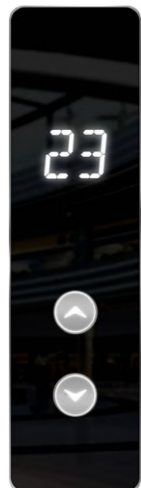

G2256
Wall-hanging

HOP

Integrated type



G2254
Wall-hanging



G2213
Embedded



G2249
Wall-hanging

Separated type

Wall-hanging



G2315



G2316

Embedded



G2302



G2216



G2206

Handicapped COP

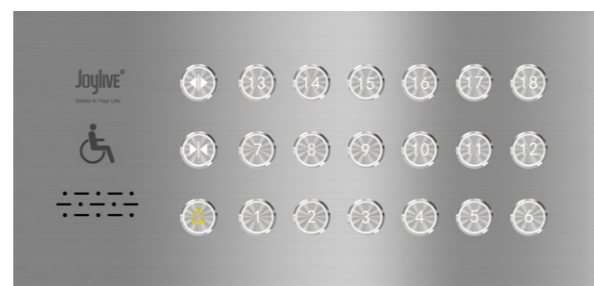

G2120
Embedded

COP Indicator

Standard

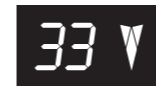

Black segmented LCD



Blue segmented LCD

Optional



Dot matrix display



7 inch picture type LCD



8/10 inch picture type display

HOP Indicator

Standard



Black segmented LCD



Blue segmented LCD

Optional



Black segmented LCD



Blue segmented LCD



Multi-media LCD



Multi-media LCD

Buttons



G2404-M
Standard



G2413-M
Optional

Hall Lantern



G2501



G2503

Ceiling design



G1013

Mirror Stainless Steel, LED Lighting

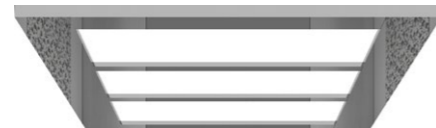

G1010

Mirror Stainless Steel, LED Lighting



G1089 (Integrated)

Hairline Stainless Steel, LED Lighting



G1090 (Integrated)

Hairline Stainless Steel, LED Lighting

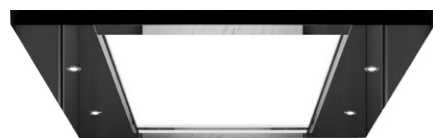

G1101

Black Mirror Stainless Steel, LED Lighting

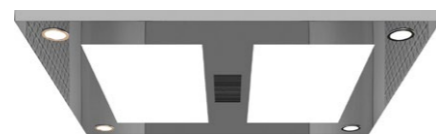

G1011

Mirror Stainless Steel, LED Lighting

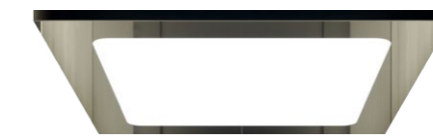

G1096

Mirror Stainless Steel, LED Lighting



G1099

Bronze Mirror Stainless Steel, Powder Coated Steel, LED Lighting, Strip Light



G1036

Mirror Stainless Steel, LED Lighting



G1062

Golden Mirror Stainless Steel, LED Lighting



G1092

Mirror Stainless Steel, Powder Coated Steel, LED Lighting, Strip Light



G1057

Powder Coated Steel, LED Lighting

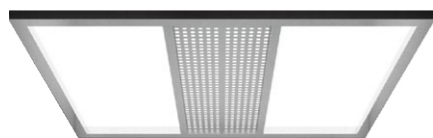

G1063

Hairline Stainless Steel, LED Lighting

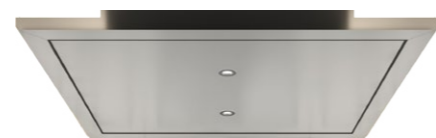

G1100

Powder Coated Steel, LED Lighting, Strip Light



G1008

Hairline Stainless Steel, LED Lighting



G1005

Hairline Stainless Steel, LED Lighting

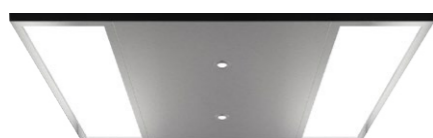

G1068

Hairline Stainless Steel, LED Lighting



G1065

Hairline Stainless Steel, LED Lighting



G1017

Hairline Stainless Steel, LED Lighting



G1091

Mirror Stainless Steel, Hairline Stainless Steel, LED Lighting

Note: Illustrations show simulated views of elevator interiors, actual illumination brightness and colors may differ. Ceiling above may not comply with all capacity elevator, please check with sales engineer before applying.

Floor

PVC Standard

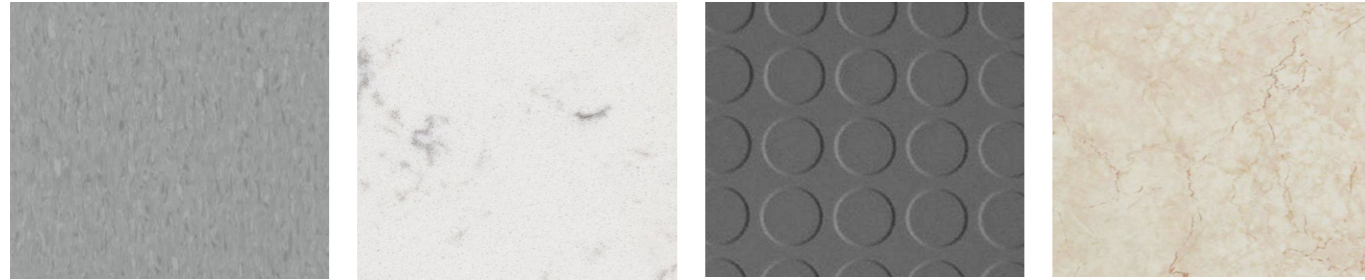

G3121

G3122

G3123

G3124

PVC Optional



G3377

G3378

G3379

G3380



G3381

G3373

G3374

G3382



G3371

G3376

G3372

G3375

Marble

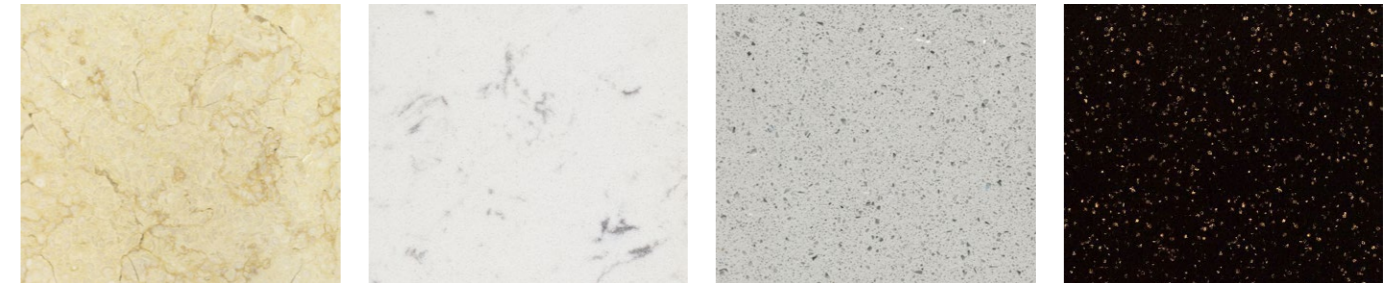

G3308

G3310

G3313

G3317



G3315

FT-01

FT-03

FT-06



G3353

G3364

G3365

G3367

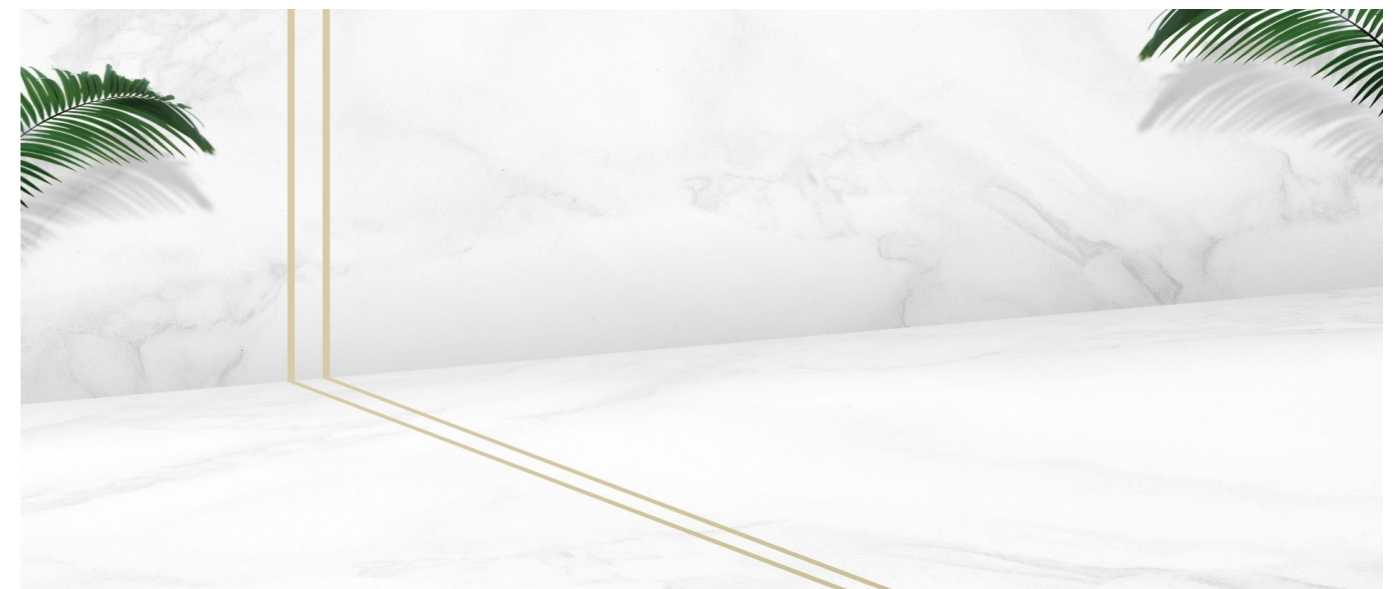

Car wall

Stainless Steel

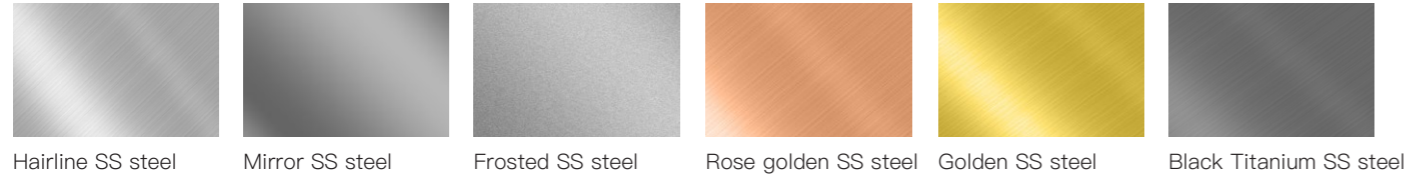

Etching Pattern (Mirror Stainless Steel)

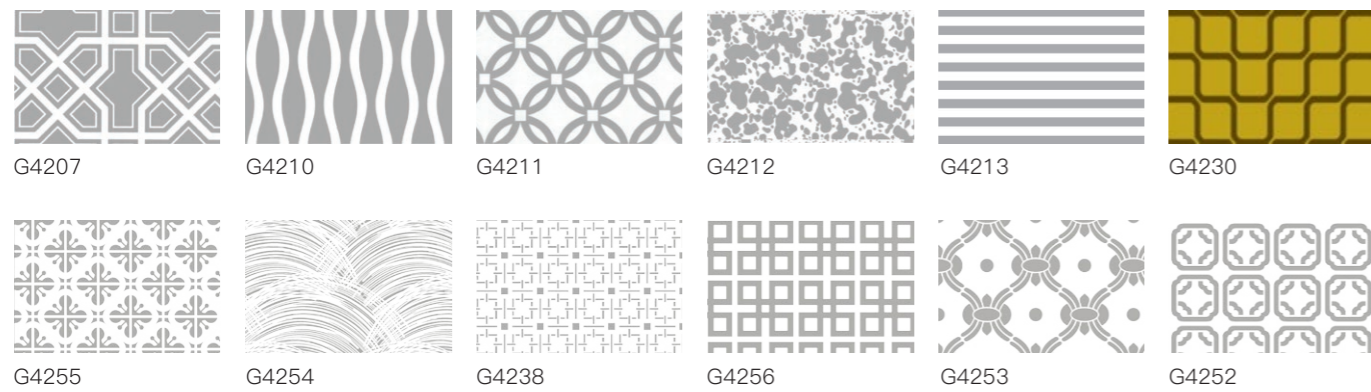

Decoration panel (Film laminated steel)

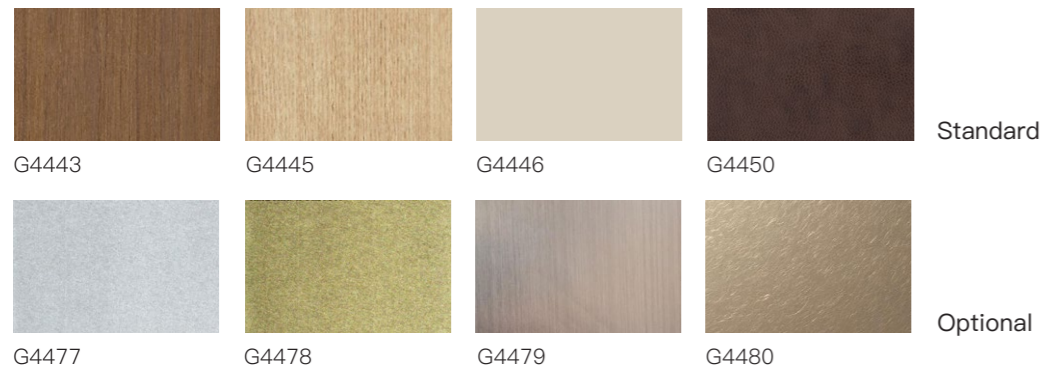

Handrail

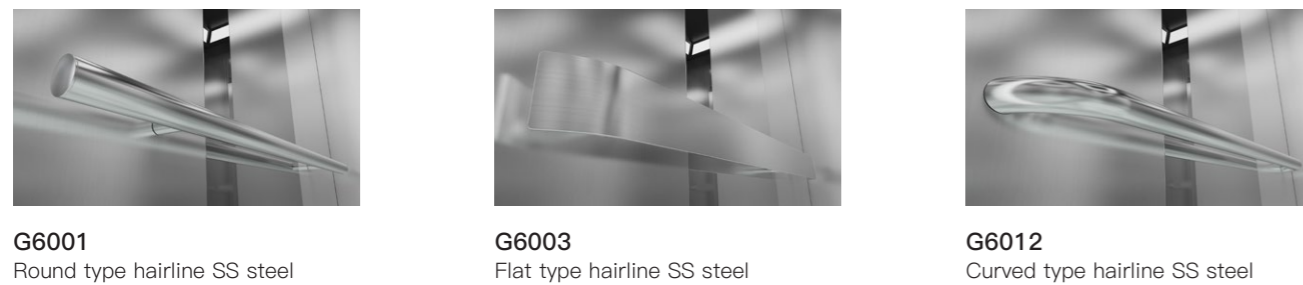

Landing door design

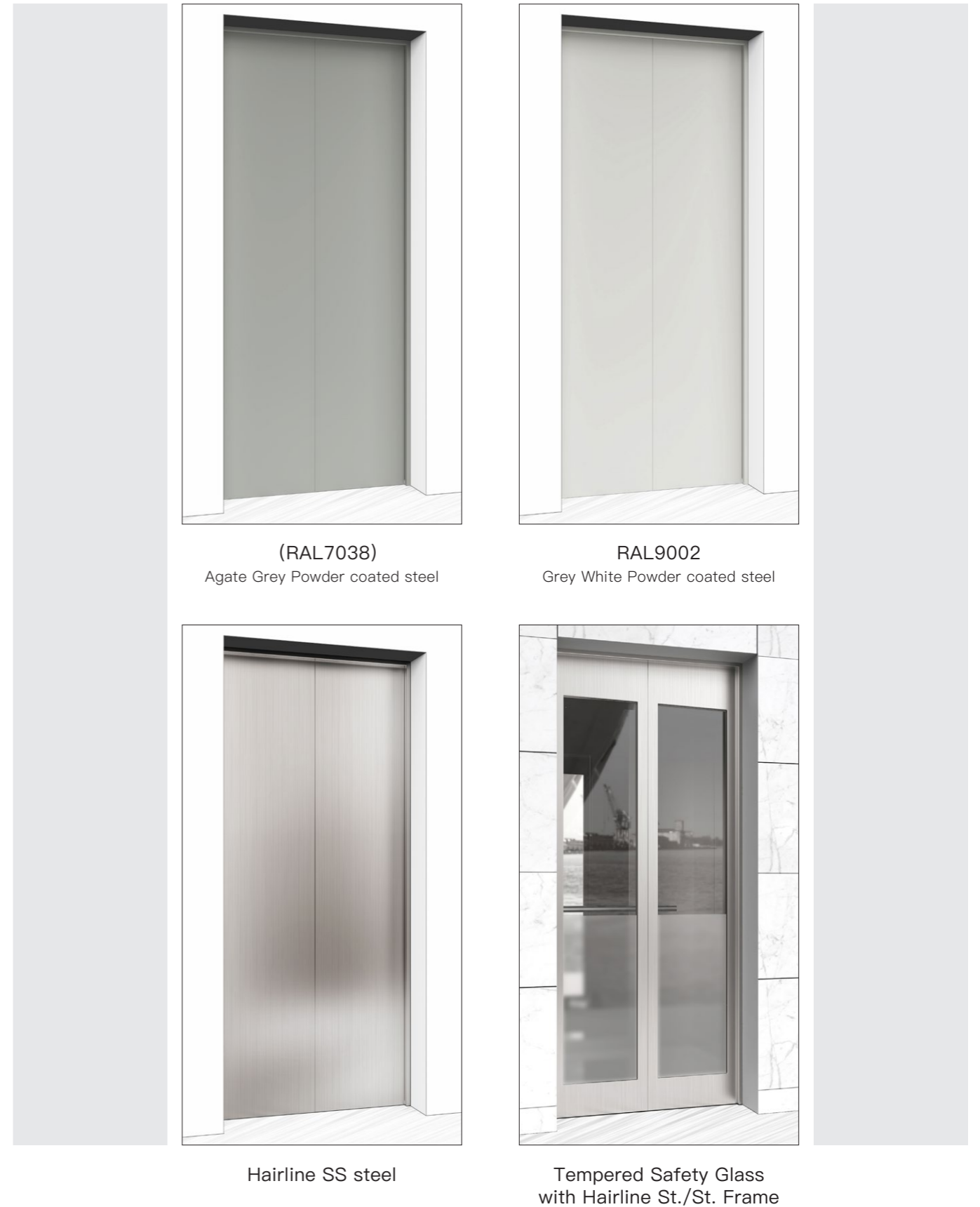

Landing door design



TM001
Mirror Etching SS Steel



TM002
Mirror Etching SS Steel



TM004
Mirror Etching SS Steel



TM008
Mirror Etching SS Steel

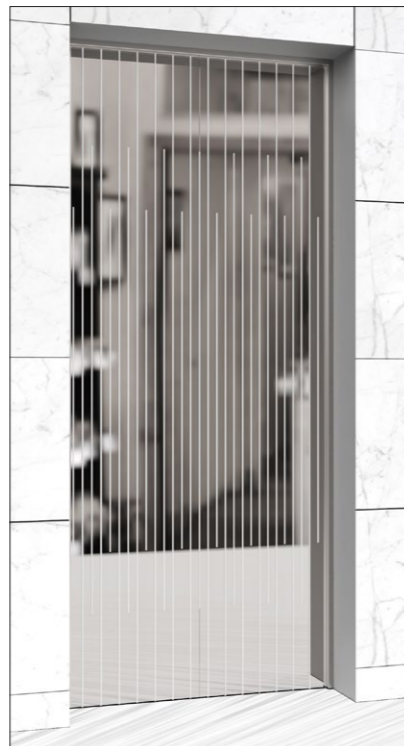

TM009
Mirror Etching SS Steel



G4213
Golden Mirror Etching SS Steel

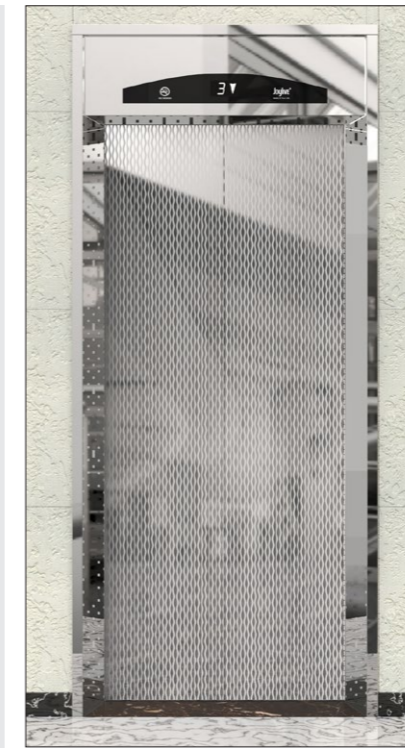

TM015
Mirror Etching SS Steel with
Wide Jamb and Transom



TM016
Mirror Etching SS Steel with
Wide Jamb and Transom



TM003
Mirror Etching SS Steel with
Wide Jamb and Transom

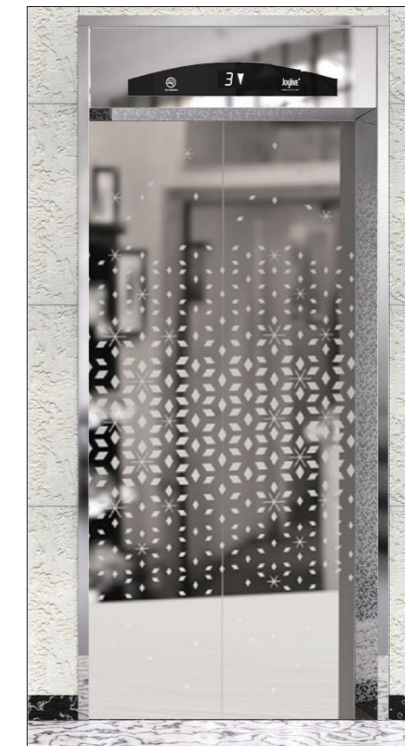

TM007
Mirror Etching SS Steel with
Wide Jamb and Transom

Products Solutions

Model/Type	Series	DESCRIPTION + SEGMENT	MACHINE ROOM	MAX.SPEED	MAX.TRAVEL	MAX.LOAD/ PERSONS
GP30 (SMR) Passenger Lift	3100 Residential Lift	Economic elevator with a compact machine room	Yes	2.5m/s	125m	1600 kg/up to 21 persons
	5200 Commercial Lift	High-speed elevator for high-rise buildings	Yes	4.0m/s	200m	2000 kg/up to 27 persons
	7000 High-speed Lift	Ultra-high-speed elevator for skyscraper buildings	Yes	8.0m/s	400m	1600 kg/up to 21 persons
GPN30 (MRL) Passenger Lift	3200 Residential Passenger Lift	Economical elevator for residential buildings	No	1.75m/s	90m	1050 kg/up to 14 persons
	5000N Commercial Passenger Lift	High-speed elevator for high-rise buildings	No	2.5m/s	125m	2000 kg/up to 27 persons
Hospital Lift	B5000S SMR Lift	Middle-speed elevator for hospital buildings	Yes	2.5m/s	125m	1600 kg/up to 21 persons
	B5000N MRL Lift	Middle-speed elevator for hospital buildings	No	2.0m/s	100m	1600 kg/up to 21 persons
Freight Lift	F200 MR Freight Lift Gearless motor	Energy-saving heavy-duty freight elevator	Yes	1.0m/s	50m	5000kg
	FN200 MRL Freight Lift Gearless motor	Energy and space saving heavy-duty freight elevator	No	1.0m/s	50m	5000kg
	GFH10 Hydraulic lift	Unique advantage and adaptability for limit space	No	0.5m/s	25m	5000kg
	F300 Explosion-Proof Elevator	Can be used in aerospace, chemical, and military industry	Yes	0.5m/s	25m	20000kg
Panoramic Lift	GO10 SMR	Wide view with strong safety glass for sighting seeing buildings	Yes	1.75m/s	90m	1600 kg/up to 21 persons
	GON30 MRL		No	1.75m/s	90m	1600 kg/up to 21 persons
GH30 Home Lift	6600 Gantry beam type	Highly customized elevator for house/ villa	No	0.4m/s	15m	400 kg/up to 5 persons
	6900 Platform type		No	0.3m/s	15m	320 kg/up to 4 persons
GE05 Escalator	E200/E300/E500	Adaptable escalator solution for public transportation	/	0.75m/s	16m	30° / 35°
GM10 Moving Walkway	M200	Adaptable moving walkway solution for public transportation	/	0.65m/s	43.47m	0° / 10° / 11° / 12°
GW05 Dumbwaiter	W100	Small space, applicable to hotels, restaurants and other places	No	0.4m/s	15m	300 kg

STANDARD FUNCTION

- | | | |
|--|--|--|
| 01.VVVF drive | 22.Overspeed protection | 44.Floor and running direction indication |
| 02.VVVF door motor drive | 23.Button stuck check | 45.Emergency lighting |
| 03.Full collective selective | 24.Micro leveling | 46.Emergency electric running |
| 04.Attendant running | 25.Fault diagnosis | 47.5-way Intercom |
| 05.Inspection running | 26.Inverted running protection | 48.Alarm bell |
| 06Automatic generation of optimum curve | 27.Motor over-current protection | 49.Returning to base floor at fire emergency |
| 07.Shaft auto-tuning | 28.Power over-voltage protection | 50.User parameter setting check |
| 08Automatic starting torque compensation | 29.Anti- nuisance function | 51.Time-based floor service |
| 09.Motor auto-tuning | 30.Encoder failure protection | 52.Security floor setting |
| 10Automatic open door when power on | 31.Door lock short cut protection | 53.Attendant running |
| 11Automatic close door | 32.Motor temperature overheat protection | 54.Independent control of the front door and back door |
| 12.Landing door open by LOP | 33Automatic return to base floor | 55.VIP service |
| 13.Repeat door close | 34.Elevator lock | 56.Force parking at destination floor |
| 14.Repeat door open | 35.Electrical brake release (MRL standard) | 57.Landing at another floor |
| 15.Door open time setting | 36.Direct travel ride | 58.Service floor setting |
| 16.Door pre-close by the door close button | 37.Running status display | 59.Running times recording |
| 17.Forced door close | 38.Car position auto-correction | 60.Running time recording |
| 18.Light curtain protection | 39.Lighting fan energy-saving function | 61.Floor display setting |
| 19.Overload protection | 40.Car arrival gong | 62.Re-leveling |
| 20.Anti-slip protection | 41.Independent running | 63.UCMP function |
| 21.Up and down limit protection | 42.Full-load direct running | 64.Door pre-opening |
| | 43.Cancellation of wrong calls | |

OPTIONAL FUNCTION

- | | | |
|-------------------------------------|--|---|
| 01.Duplex control operation | customized) | 17.Through opening door function (180 degree or 90 degree)" |
| 02.Group control operation | 10.Air conditioning (cold/Hot) | 18.Auxiliary COP |
| 03.Peak service control operation | 11.Car air purification system | 19.Handicapped COP |
| 04.ARD (automatic rescue device) | 12.Intelligent elevator ultraviolet virus killing system | 20.Micro-light button |
| 05.Energy regeneration function | 13.Wired remote monitoring | 21.Multimedia screen (18.5inch/23 inch display) |
| 06.Voltage stabilizer | 14.Wireless remote monitoring | 22.Internet of things (IoT) function |
| 07.IC card access control (COP/HOP) | 15.Seismic / earthquake sensor | |
| 08.CCTV cable with/without camera | 16.Firefighter running | |
| 09.Voice synthesizer(CH/EN/RU/ | | |

Planning & Specification

MR Passenger Elevator 3100 (GP30)

Load	Speed	Cabin Size	Door Opening	C.W.layout	Door type	Shaft size	Pit depth	Top Floor Height
kg	m/s	CW×CD	EW×EH			HW×HD	PD(mm)	TH(mm)
450	1	1100×1100	700×2100	C.W. at rear	CO	1600×1800	1350	4400
	1.5						1350	4450
	1.75						1350	4500
630	1	1400×1100	800×2100	C.W. at rear	CO	1900×1700	1350	4400
	1.5						1350	4450
	1.75						1350	4500
630	1	1100×1400	800×2100	C.W. at side	CO/Double entrance	2000×1900	1350	4400
	1.5						1350	4450
	1.75						1350	4500
800 (825)	1	1400×1350	800×2100	C.W. at rear	CO	1900×1950	1350	4400
	1.5						1350	4450
	1.75						1350	4500
	2.0						1600	4800
800 (825)	1	1350×1400	800×2100	C.W. at side	CO/Double entrance	2200×1900	1350	4400
	1.5						1350	4450
	1.75						1350	4500
	2.0						1600	4800
1000	1	1600×1400	900×2100	C.W. at rear	CO	2100×2000	1350	4400
	1.5						1350	4450
	1.75						1350	4500
	2.0						1600	4800
1000	1	1400×1600	900×2100	C.W. at side	CO/Double entrance	2300×2100	1350	4400
	1.5						1350	4450
	1.75						1350	4500
	2.0						1600	4800
1000 (1050) (Bed lift)	1	1100×2100	900×2100	C.W. at side	SO	1850×2550	1350	4400
	1.5						1350	4450
	1.75						1350	4500
	2.0						1600	4800
1000 (1050) (Bed lift)	1	1100×2100	900×2100	C.W. at side	CO	2050×2500	1350	4400
	1.5						1350	4450
	1.75						1350	4500
	2.0						1600	4800
1150	1	1800×1400	1000×2100	C.W. at rear	CO	2300×2100	1350	4400
	1.5						1350	4450
	1.75						1350	4500
	2.0						1600	5000
1250	1	1900×1500	1100×2100	C.W. at rear	CO	2400×2200	1350	4400
	1.5						1350	4450
	1.75						1350	4500
	2.0						1700	5000
1350	1	1900×1600	1100×2100	C.W. at rear	CO	2400×2300	1350	4400
	1.5						1350	4450
	1.75						1350	4500
	2.0						1700	5000
1600	1	2000×1700	1100×2100	C.W. at rear	CO	2500×2450	1350	4400
	1.5						1350	4450
	1.75						1350	4500
	2.0						1700	5000

MRL Passenger Elevator 3200 (GPN30)

Load	Speed	Cabin Size	Door Opening	C.W.layout	Door type	Shaft size	Pit depth	Top Floor Height
kg	m/s	CW×CD	EW×EH			HW×HD	PD(mm)	TH(mm)
450	1	1100×1100	700×2100	C.W. at side	CO	1900×1500	1500	4250
	1.5						1550	4300
	1.75						1600	4350
630	1	1100×1400	700×2100	C.W. at side	CO	1850×1850	1500	4250
	1.5						1550	4300
	1.75						1600	4350
630	1	1100×1400	700×2100	C.W. at side	CO/Double entrance	1850×1900	1500	4250
	1.5						1550	4300
	1.75						1600	4350
	1.75						1600	4350
800 (825)	1	1350×1400	800×2100	C.W. at side	CO	2100×1850	1500	4250
	1.5						1550	4300
	1.75						1600	4350
800 (825)	1	1350×1400	800×2100	C.W. at side	CO/Double entrance	2100×1900	1500	4250
	1.5						1550	4300
	1.75						1600	4350
1000	1	1600×1400	900×2100	C.W. at side	CO	2350×1850	1500	4250
	1.5						1550	4300
	1.75						1600	4350
1000	1	1400×1600	900×2100	C.W. at side	CO/Double entrance	2250×2100	1500	4250
	1.5						1550	4300
	1.75						1600	4350
1000 (1050) (Bed lift)	1	1100×2100	900×2100	C.W. at side	SO	1850×2550	1500	4250
	1.5						1550	4300
	1.75						1600	4350
1000 (1050) (Bed lift)	1	1100×2100	900×2100	C.W. at side	CO	2100×2500	1500	4250
	1.5						1550	4300
	1.75						1600	4350
1150	1	1800×1400	1100×2100	C.W. at side	CO	2700×1800	1500	4350
	1.5						1550	4400
	1.75						1600	4450
1250	1	1900×1500	1100×2100	C.W. at side	CO	2800×1900	1500	4350
	1.5						1550	4450
	1.75						1600	4500
1350	1	1900×1600	1100×2100	C.W. at side	CO	2800×2000	1500	4350
	1.5						1550	4450
	1.75						1600	4500
1600	1	2000×1800	1100×2100	C.W. at side	CO	2900×2200	1500	4350
	1.5						1550	4450
	1.75						1600	4500

MR Passenger Elevator 3600 (GP30)

Load	Speed	Cabin Size	Door Opening	Entrance	Door type	Shaft size	Pit depth	Top Floor Height
kg	m/s	CW×CD	EW×EH			HW×HD	PD(mm)	TH(mm)
800 (825)	2	1400×1350	800×2100	Single	CO	2000×2050	1600	4700
	2.5						1900	4950
1000	2	1600×1400	900×2100	Single	CO	2200×2100	1600	4700
	2.5						1900	4950
1050	2	1600×1500	900×2100	Single	CO	2200×2200	1600	4700
	2.5						1900	4950
1150	2	1800×1400	1000×2100	Single	CO	2400×2200	1600	4700
	2.5						1900	4950
1250	2	1900×1500	1100×2100	Single	CO	2500×2300	1600	4700
	2.5						1900	4950
1350	2	1900×1600	1100×2100	Single	CO	2500×2400	1600	4700
	2.5						1900	4950

Planning & Specification

MR Passenger Elevator 3100-R (GP30)

Load	Speed	Cabin Size	Door Opening	Shaft size	Pit depth	Top Floor Height
kg	m/s	CW×CD	EW×EH	HW×HD	PD(mm)	TH(mm)
400	1	1000×1000	2S 800×2000	1550×1500	1300	3600
	1.5				1400	3800
	1.75				1400	3800
400	1	1000×1000	CO 700×2000	1550×1400	1300	3600
	1.5				1400	3800
	1.75				1400	3800
450	1	1100×1100	2S 800×2000	1650×1500	1300	3600
	1.5				1400	3800
	1.75				1400	3800
450	1	1100×1100	CO 700×2000	1650×1450	1300	3600
	1.5				1400	3800
	1.75				1400	3800
630	1	1100×1400	2S 900×2000	1650×1800	1300	3600
	1.5				1400	3800
	1.75				1400	3800
630	1	1100×1400	CO 700×2000	1650×1700	1300	3600
	1.5				1400	3800
	1.75				1400	3800
800	1	1350×1400	CO 800×2000	1900×1700	1300	3600
	1.5				1400	3800
	1.75				1400	3800
1000	1	2100×1100	2S 1200×2000	2650×1650	1300	3600
	1.5				1400	3800
	1.75				1400	3800
1000	1	1600×1400	CO 1000×2000	2150×1700	1300	3600
	1.5				1400	3800
	1.75				1400	3800
1000	1	1100×2100	2S 900×2000	1650×2500	1300	3600
	1.5				1400	3800
	1.75				1400	3800
1000	1	1100×2100	CO 800×2000	1800×2400	1300	3600
	1.5				1400	3800
	1.75				1400	3800

Note:
Special designed passenger elevator structure for narrow space shaft and low overhead.

MRL Passenger Elevator 3200-R (GPN30)

Load	Speed	Cabin Size	Door Opening	Shaft size	Pit depth	Top Floor Height
kg	m/s	CW×CD	EW×EH	HW×HD	PD(mm)	TH(mm)
400	1	1000×1000	2S 800×2000	1550×1500	1200	3800
	1.5				1300	3900
	1.75				1300	3950
400	1	1000×1000	CO 700×2000	1550×1400	1200	3800
	1.5				1300	3900
	1.75				1300	3950
450	1	1100×1100	2S 800×2000	1650×1500	1200	3800
	1.5				1300	3900
	1.75				1300	3950
450	1	1100×1100	CO 700×2000	1650×1450	1200	3800
	1.5				1300	3900
	1.75				1300	3950
630	1	1100×1400	2S 900×2000	1650×1800	1200	3800
	1.5				1300	3900
	1.75				1300	3950
630	1	1100×1400	CO 700×2000	1650×1700	1200	3800
	1.5				1300	3900
	1.75				1300	3950
800	1	1350×1400	CO 800×2000	1900×1700	1200	3800
	1.5				1300	3900
	1.75				1300	3950
1000	1	2100×1100	2S 1200×2000	2650×1650	1200	3800
	1.5				1300	3900
	1.75				1300	3950
1000	1	1600×1400	CO 1000×2000	2150×1700	1200	3800
	1.5				1300	3900
	1.75				1300	3950
1000	1	1100×2100	2S 900×2000	1650×2500	1200	3800
	1.5				1300	3900
	1.75				1300	3950
1000	1	1100×2100	CO 800×2000	1800×2400	1200	3800
	1.5				1300	3900
	1.75				1300	3950

Note:
Special designed passenger elevator structure for narrow space shaft and low overhead.
Steel plate will be used as Counter weight filler.*

Planning & Specification

MR Commercial Passenger Elevator 5000S (GP30)

Load	Speed	Cabin Size	Door Opening	C.W.layout	Door type	Shaft size	Pit depth	Top Floor Height
kg	m/s	CW×CD	EW×EH			HW×HD	PD(mm)	TH(mm)
800 (825)	1	1400×1350	800×2100	C.W. at rear	CO	1900×1950	1350	4400
	1.5						1350	4450
	1.75						1350	4500
800 (825)	1	1350×1400	800×2100	C.W. at side	CO/Double entrance	2200×1900	1350	4400
	1.5						1350	4450
	1.75						1350	4500
1000	1	1600×1400	900×2100	C.W. at rear	CO	2100×2000	1350	4400
	1.5						1350	4450
	1.75						1350	4500
1000	1	1400×1600	900×2100	C.W. at side	CO/Double entrance	2300×2100	1350	4400
	1.5						1350	4450
	1.75						1350	4500
1000 (1050) Bed lift	1	1100×2100	900×2100	C.W. at side	SO	1850×2550	1350	4400
	1.5						1350	4450
	1.75						1350	4500
1000 (1050) Bed lift	1	1100×2100	900×2100	C.W. at side	CO	2050×2500	1350	4400
	1.5						1350	4450
	1.75						1350	4500
1050	1	1600×1500	900×2100	C.W. at rear	CO	2100×2100	1350	4400
	1.5						1350	4450
	1.75						1350	4500
1050	1	1500×1600	900×2100	C.W. at side	CO/Double entrance	2400×2100	1350	4400
	1.5						1350	4450
	1.75						1350	4500
1150	1	1800×1400	1000×2100	C.W. at rear	CO	2300×2100	1350	4400
	1.5						1350	4450
	1.75						1350	4500
1250	1	1900×1500	1100×2100	C.W. at rear	CO	2400×2300	1400	4450
	1.5						1450	4500
	1.75						1450	4600
1350	1	1900×1600	1100×2100	C.W. at rear	CO	2400×2400	1400	4450
	1.5						1450	4500
	1.75						1450	4600
1600	1	2000×1700	1200×2100	C.W. at rear	CO	2600×2500	1400	4450
	1.5						1450	4500
	1.75						1450	4600
1600	1	1400×2400	1200×2100	C.W. at side	SO	2400×2900	1400	4450
	1.5						1450	4500
	1.75						1450	4600
2000	1	2000×2000	1100×2100	C.W. at rear	CO	2600×2800	1400	4450
	1.5						1450	4500
	1.75						1450	4600
2000	1	1600×2600	1200×2100	C.W. at side	CO	2900×3000	1400	4450
	1.5						1450	4500
	1.75						1450	4600

MRL Commercial Passenger Elevator 5000N (GPN30)

Load	Speed	Cabin Size	Door Opening	C.W.layout	Door type	Shaft size	Pit depth	Top Floor Height
kg	m/s	CW×CD	EW×EH			HW×HD	PD(mm)	TH(mm)
800 (825)	1	1350×1400	800×2100	C.W. at side	CO	2100×1850	1500	4250
	1.5						1550	4300
	1.75						1600	4350
800 (825)	1	1350×1400	800×2100	C.W. at side	CO/Double entrance	2100×1900	1500	4250
	1.5						1550	4300
	1.75						1600	4350
1000	1	1600×1400	900×2100	C.W. at side	CO	2350×1850	1500	4250
	1.5						1550	4300
	1.75						1600	4350
1000 (1050) Bed lift	1	1100×2100	900×2100	C.W. at side	CO	2050×2500	1500	4400
	1.5						1550	4450
	1.75						1600	4500
1050	1	1600×1500	900×2100	C.W. at side	CO	2100×2100	1500	4400
	1.5						1550	4450
	1.75						1600	4500
1150	1	1800×1400	1000×2100	C.W. at side	CO	2300×2100	1500	4400
	1.5						1550	4450
	1.75						1600	4500
1250	1	1900×1500	1100×2100	C.W. at side	CO	2700×1900	1550	4150
	1.5						1600	4200
	1.75						1650	4250
1350	1	1900×1600	1100×2100	C.W. at side	CO	2700×2000	1550	4150
	1.5						1600	4200
	1.75						1650	4250
1600	1	2000×1800	1200×2100	C.W. at side	CO	2850×2200	1550	4200
	1.5						1600	4250
	1.75						1650	4300
2000	1	2000×2000	1100×2100	C.W. at side	CO	2850×2400	1550	4200
	1.5						1600	4250
	1.75						1650	4300

Planning & Specification

MR Panoramic Elevator GO10 (GP30)

Load	Speed	Cabin Size	Door Opening	Shaft size	Pit depth	Top Floor Height
kg	m/s	CW×CD	EW×EH	HW×HD	PD(mm)	TH(mm)
630	1	1100×1400	CO 700×2100	2000×2000	1800	4500
	1.5				1850	4600
	1.75				1900	4650
630	1	1100×1600	CO 700×2100	2000×2200	1800	4500
	1.5				1850	4600
	1.75				1900	4650
800	1	1300×1500	CO 800×2100	2200×2100	1850	4600
	1.5				1900	4650
	1.75				1950	4700
800	1	1200×1750	CO 800×2100	2100×2350	1850	4600
	1.5				1900	4650
	1.75				1950	4700
1000	1	1500×1500	CO 900×2100	2400×2100	1900	4650
	1.5				1950	4700
	1.75				2000	4750
1000	1	1300×1900	CO 900×2100	2200×2500	1900	4650
	1.5				1950	4700
	1.75				2000	4750
1250	1	1600×1700	CO 1000×2100	2500×2300	2000	4750
	1.5				2050	4800
	1.75				2100	4850
1250	1	1500×2000	CO 900×2100	2400×2600	2000	4750
	1.5				2050	4800
	1.75				2100	4850
1350	1	1800×1700	CO 1100×2100	2700×2300	2050	4800
	1.5				2100	4850
	1.75				2150	4900
1350	1	1600×2000	CO 1100×2100	2500×2600	2050	4800
	1.5				2100	4850
	1.75				2150	4900
1600	1	1900×1800	CO 1100×2100	2900×2400	2150	4900
	1.5				2200	4950
	1.75				2250	5000
1600	1	1800×2100	CO 1100×2100	2800×2700	2150	4900
	1.5				2200	4950
	1.75				2250	5000

MRL Panoramic Elevator GON30 (GPN30)

Load	Speed	Cabin Size	Door Opening	Shaft size	Pit depth	Top Floor Height
kg	m/s	CW×CD	EW×EH	HW×HD	PD(mm)	TH(mm)
630	1	1100×1400	CO 700×2100	2000×2000	1700	4650
	1.5				1750	4700
	1.75				1800	4750
630	1	1100×1600	CO 700×2100	2000×2200	1700	4650
	1.5				1750	4700
	1.75				1800	4750
800	1	1300×1500	CO 800×2100	2200×2100	1750	4650
	1.5				1800	4700
	1.75				1850	4750
800	1	1200×1750	CO 800×2100	2100×2350	1750	4650
	1.5				1800	4700
	1.75				1850	4750
1000	1	1500×1500	CO 900×2100	2400×2100	1800	4700
	1.5				1850	4750
	1.75				1900	4800
1000	1	1300×1900	CO 900×2100	2200×2500	1800	4700
	1.5				1850	4750
	1.75				1900	4800
1250	1	1600×1700	CO 1000×2100	2500×2300	1900	4800
	1.5				1950	4850
	1.75				2000	4900
1250	1	1500×2000	CO 900×2100	2400×2600	1900	4800
	1.5				1950	4850
	1.75				2000	4900

Planning & Specification

MRL Freight Elevator FN200(GFN20 GFN30)

Load	Speed	Cabin Size	Door Opening	Door type	Shaft size	Pit depth	Top Floor Height
kg	m/s	CW×CD	EW×EH		HW×HD	PD(mm)	TH(mm)
1000	1.0	1400×1700	1400×2100	Single/CO-4P	2500×2200	1600	4300
	1.5					1600	4600
	1.0	1400×1700	1200×2100	Double/SO	2400×2250	1600	4300
	1.5					1600	4600
1600	0.5	1500×2300	1500×2100	Single/CO-4P	2850×2700	1600	4500
	1.0						
	0.5	1500×2300	1500×2100	Double/CO-4P	2850×2850	1600	4500
	1.0						
2000	0.5	1700×2400	1700×2100	Single/CO-4P	3050×2800	1600	4500
	1.0						
	0.5	1700×2400	1700×2100	Double/CO-4P	3050×2950	1600	4500
	1.0						
3000	0.5	2000×2800	1800×2100	Single/CO-4P	3350×3250	1600	4600
	1.0						
	0.5	2000×2800	1800×2100	Double/CO-4P	3350×3350	1600	4600
	1.0						
4000	0.5	2200×3300	2200×2300	Single/CO-4P	4000×3700	1700	4600
	1.0						
	0.5	2200×3300	2200×2300	Double/CO-4P	4000×3850	1700	4600
	1.0						
5000	0.5	2400×3600	2400×2300	Single/CO-4P	4200×4000	1700	4600
	1.0						
	0.5	2400×3600	2400×2300	Double/CO-4P	4200×4150	1700	4800
	1.0						

Note: 1. Standard car height CH=EH+100. 2. Standard top floor height is 5100mm when traveling height ≥ 25m.

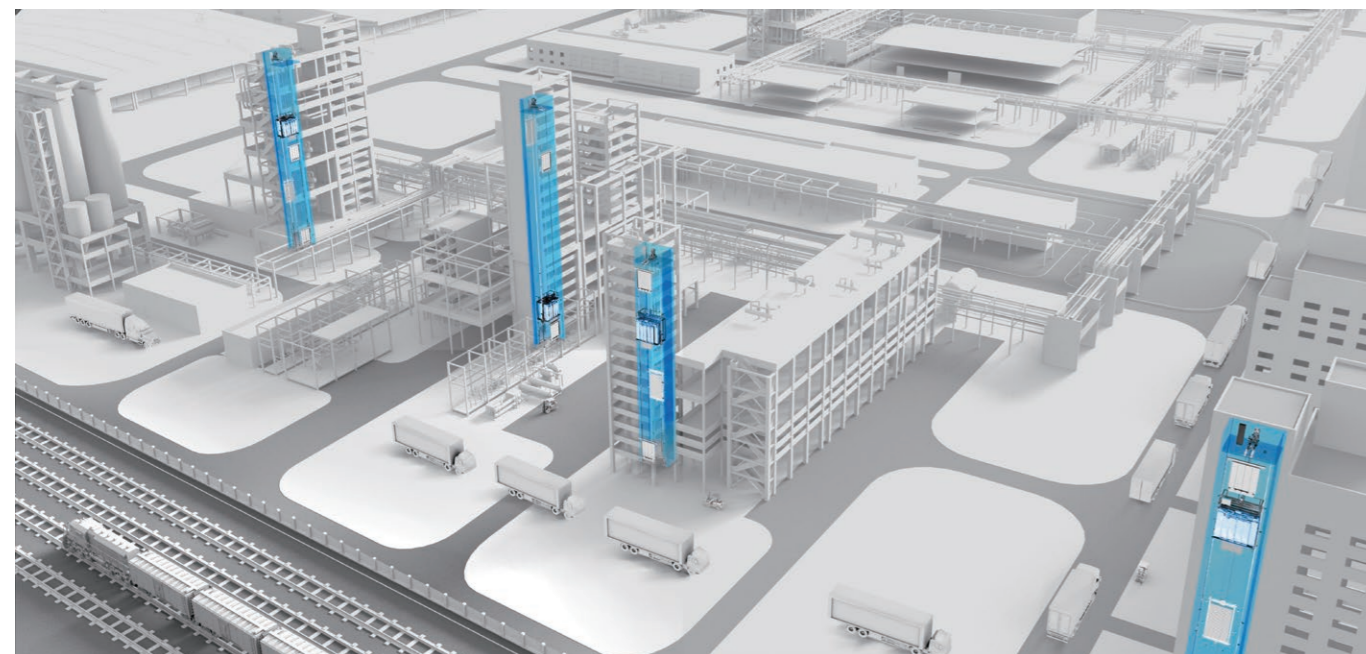

MR Freight Elevator F200(GF10)

Load	Speed	Cabin Size	Door Opening	Entrance	Door type	Shaft size	Pit depth	Top Floor Height
kg	m/s	CW×CD	EW×EH			HW×HD	PD(mm)	TH(mm)
1600	0.5	1500×2300	1500×2100	Single	CO-4P	2700×2700	1500	4300
	1.0							
	0.5	1500×2300	1500×2100	Double	CO-4P	2700×2850	1500	4300
	1.0							
2000	0.5	1700×2400	1700×2100	Single	CO-4P	2950×2850	1500	4300
	1.0							
	0.5	1700×2400	1700×2100	Double	CO-4P	2950×2950	1500	4300
	1.0							
2500	0.5	2000×2500	1800×2100	Single	CO-4P	3250×2950	1500	4300
	1.0							
	0.5	2000×2500	1800×2100	Double	CO-4P	3250×3050	1500	4300
	1.0							
3000	0.5	2000×2800	1800×2100	Single	CO-4P	3250×3250	1500	4300
	1.0							
	0.5	2000×2800	1800×2100	Double	CO-4P	3250×3350	1500	4300
	1.0							
4000	0.5	2200×3300	2200×2300	Single	CO-4P	3800×3750	1500	4500
	1.0							
	0.5	2100×3500	2100×2300	Double	CO-4P	3650×4050	1500	4500
	1.0							
5000	0.5	2400×3600	2400×2300	Single	CO-4P	4000×4050	1600	4800
	1.0							
	0.5	2400×3600	2400×2300	Double	CO-4P	4000×4150	1600	4800
	1.0							

F200 Heavy-duty type

7000	0.5	3000×4000	3000×3000	Single	CO-6P	4700×4600	1700	5200
				Double		4700×4700		
10000	0.5	3400×4900	3000×3000	Single	CO-6P	5300×5200	2000	5750
				Double		5300×5400		
20000	0.5	4600×7000	4000×3500	Single	CO-6P	6400×7650	2500	5800
				Double		6400×7850		

Note: 1. Standard car height CH=EH+100. 2. Door type can be CO-4P when door opening is 3000mm. 3. Elevator load can be customized according to project, please contact with Joylive sales engineers.